



SCHOTTKY DIODE MODULE TYPE 2X120A / 80V

Features

- High Surge Capability
- Type 80V V_{RRM}
- Isolation Type Package
- Electrically Isolation Base Plate
- RoHS Compliant

Maximum Ratings

Junction Operating Temperature : -40°C to +150°C

Storage Temperature : -40°C to +150°C

Part Number	Maximum Recurrent Peak Reverse Voltage	Maximum RMS Voltage	Maximum DC Blocking Voltage
MBRI2X120-080A	80V	56V	80V

Electrical Characteristics @ 25°C Unless Otherwise Specified

Average Forward Current (Per pkg) (Per diode)	$I_{F(AV)}$	240A 120A	$T_C = 110^\circ\text{C}$
Peak Forward Surge Current (Per diode)	I_{FSM}	1800A	8.3ms, half sine
Maximum Instantaneous Forward Voltage* (Per diode)	V_F	0.73V 0.84V	$I_{FM} = 120\text{A}; T_J = 125^\circ\text{C}$ $I_{FM} = 120\text{A}; T_J = 25^\circ\text{C}$
Maximum Instantaneous Reverse Current At Rated DC Blockig Voltage* (Per diode)	I_R	1mA 10mA 30mA	$T_J = 25^\circ\text{C}$ $T_J = 100^\circ\text{C}$ $T_J = 150^\circ\text{C}$
Isolation Voltage	V_{iso}	2500V	A.C. 1 minute
Maximum Thermal Resistance Junction To Case (Per diode)	$R_{\theta jc}$	0.38°C/W	
Mounting Torque		1.3Nm	M4 Screw

*Pulse Test: Pulse Width 300 μ sec, Duty Cycle < 2%

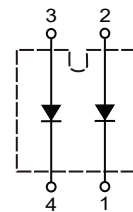
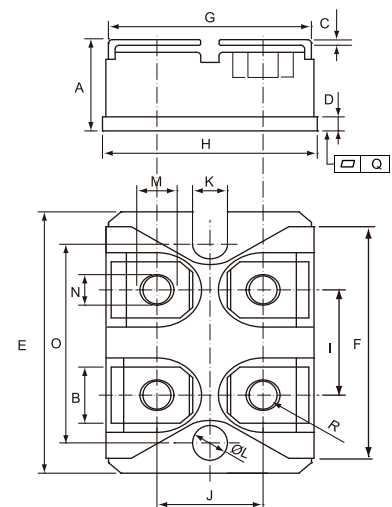

MBRI 2X120 - xxxA

	DIMENSIONS			
	INCHES		MM	
	MIN	MAX	MIN	MAX
A	0.460	0.483	11.68	12.28
B	0.307	0.323	7.80	8.20
C	0.030	0.033	0.75	0.85
D	0.071	0.081	1.80	2.05
E	1.488	1.504	37.80	38.20
F	1.248	1.260	31.70	32.00
G	0.917	0.957	23.30	24.30
H	0.996	1.008	25.30	25.60
I	0.579	0.602	14.70	15.30
J	0.492	0.516	12.50	13.10
K	0.161	0.169	4.10	4.30
L	0.161	0.169	4.10	4.30
M	0.181	0.197	4.60	5.00
N	0.165	0.181	4.20	4.60
O	1.181	1.197	30.00	30.40
Q	-0.002	0.004	-0.05	0.10
R	M4*8			



Figure.1 - Typical Forward Characteristics

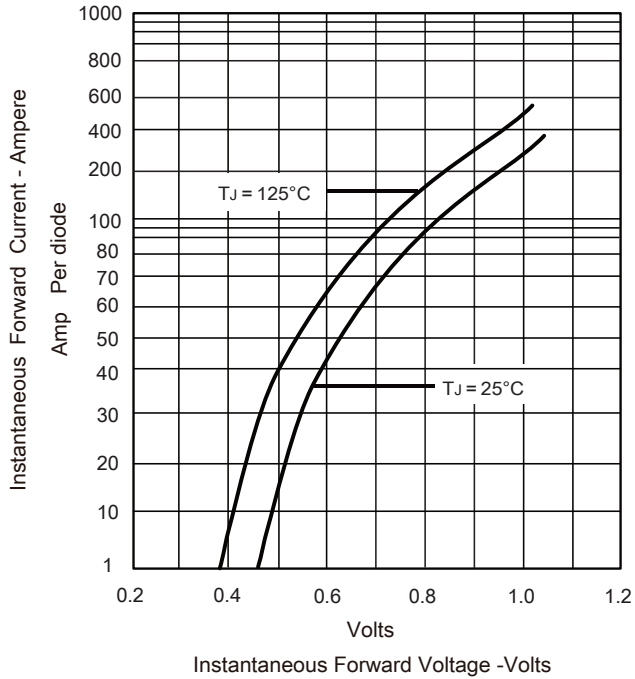

Figure.2 - Forward Derating Curve

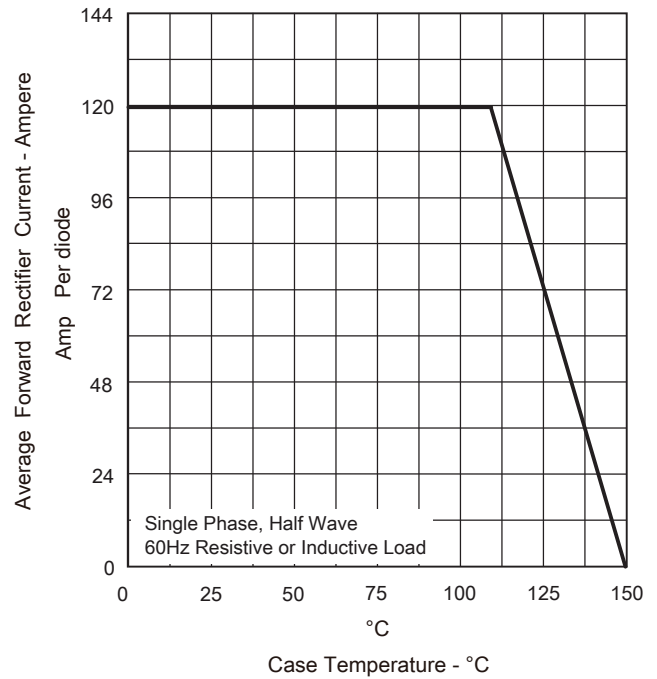

Figure.3 - Peak Forward Surge Current

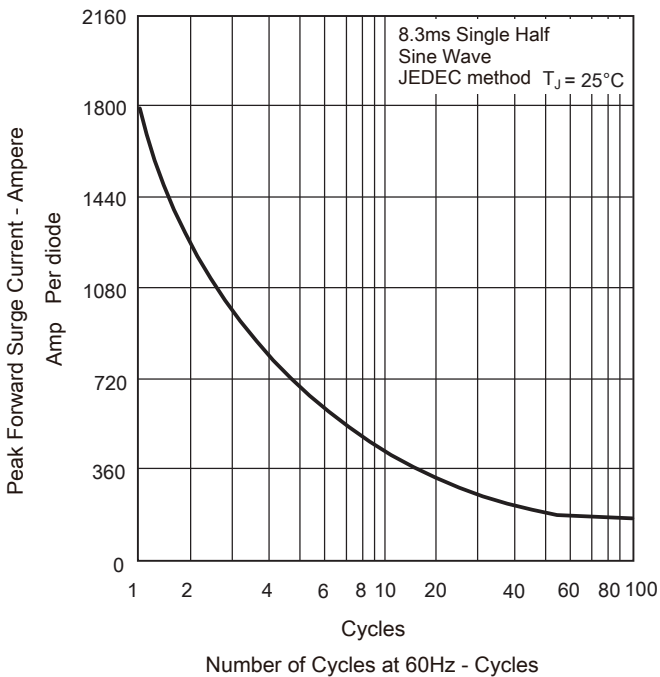
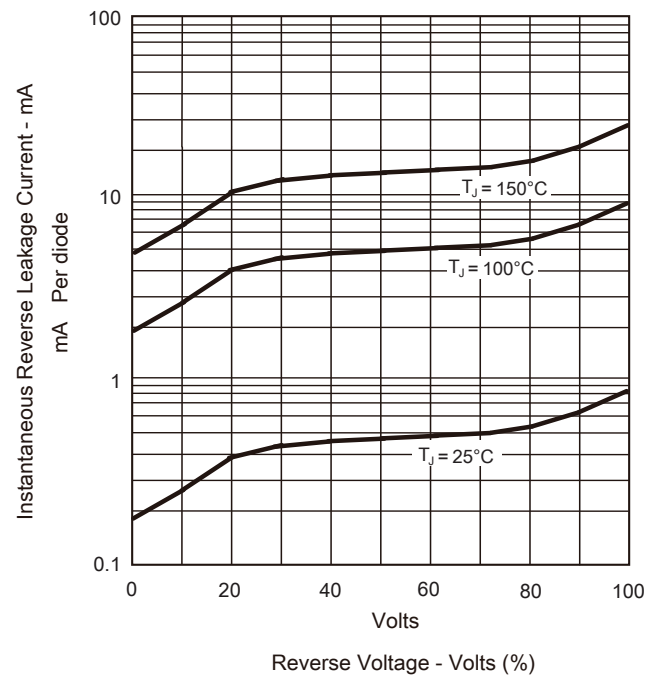

Figure.4 - Typical Reverse Characteristics





Disclaimer

DACO Semiconductor reserve the right to make modifications, enhancements, improvements, corrections or other changes without further notice to this document and any product described herein.

DACO Semiconductor makes no warranty, representation or guarantee regarding the suitability of its products for any particular purpose, nor does DACO Semiconductor assume any liability arising out of the application or use of any product or circuit, and specifically disclaims any and all liability, including without limitation special, consequential or incidental damages.

Purchasers is responsible for its products and applications using DACO Semiconductor products, including compliance with all laws, regulations and safety requirements or standards, regardless of any support or applications information provided by DACO Semiconductor. "Typical" parameters which may be provided in DACO Semiconductor data sheets and/or specifications can and do vary in different applications and actual performance may vary over time. All operating parameters, including "Typicals" must be validated for each customer application by customer's technical experts.

DACO Semiconductor products are not designed, authorized or warranted to be suitable for use in life support, life-critical or safety-critical systems or equipment, nor in applications where failure or malfunction of DACO Semiconductor's product can reasonably be expected to result in personal injury, death or severe property or environmental damage. DACO Semiconductor accept no liability for inclusion and/or use of DACO Semiconductor's products in such equipment or applications and therefore such inclusion and/or use is at the customer's own risk.

Purchasers buy or use DACO Semiconductor products for any such unintended or unauthorized application, Purchasers shall indemnify and hold DACO Semiconductor and its suppliers and distributors harmless against all claims, costs, damages, and expenses, and reasonable attorney fees arising out of, directly or indirectly, any claim of personal injury or death associated with such unintended or unauthorized use, even if such claim alleges that DACO Semiconductor was negligent regarding the design or manufacture of the part.

No part of this publication may be reproduced or transmitted in any form or by any means, electronic or mechanical, including photocopying and recording, or any information storage or retrieval system, or otherwise, without the prior written permission of DACO Semiconductor Co., Ltd.